

# AutoCAD 2011: One Step at a Time

## Lesson 24: Space for a New Beginning

<b>11R24</b>	<b>Exercises</b>
--------------	------------------

1. Open the *needle* file in the C:\Steps\Lesson24 folder. Create the drawing configuration for plotting shown. Some helpful information includes:

- 1.1. The page size is A4 (metric – 210mm x 297mm).
- 1.2. The title block is the *ISO-A4* file found in AutoCAD's Template folder. (You may need to adjust its position on the sheet.)
- 1.3. The title block text is attributed.
- 1.4. Watch your layers (place viewports on the **VPorts** layer).
- 1.5. The radius of the large circle is 60mm; the radius of the smaller circle is 36mm.
- 1.6. Remember that floating viewports can overlap.
- 1.7. The scale of each viewport (from top to bottom) is 10:1, 8:1, 2:1.
- 1.8. Fill in the title block as desired.
- 1.9. Save the drawing as *MyNeedle* in the C:\Steps\Lesson24 folder.

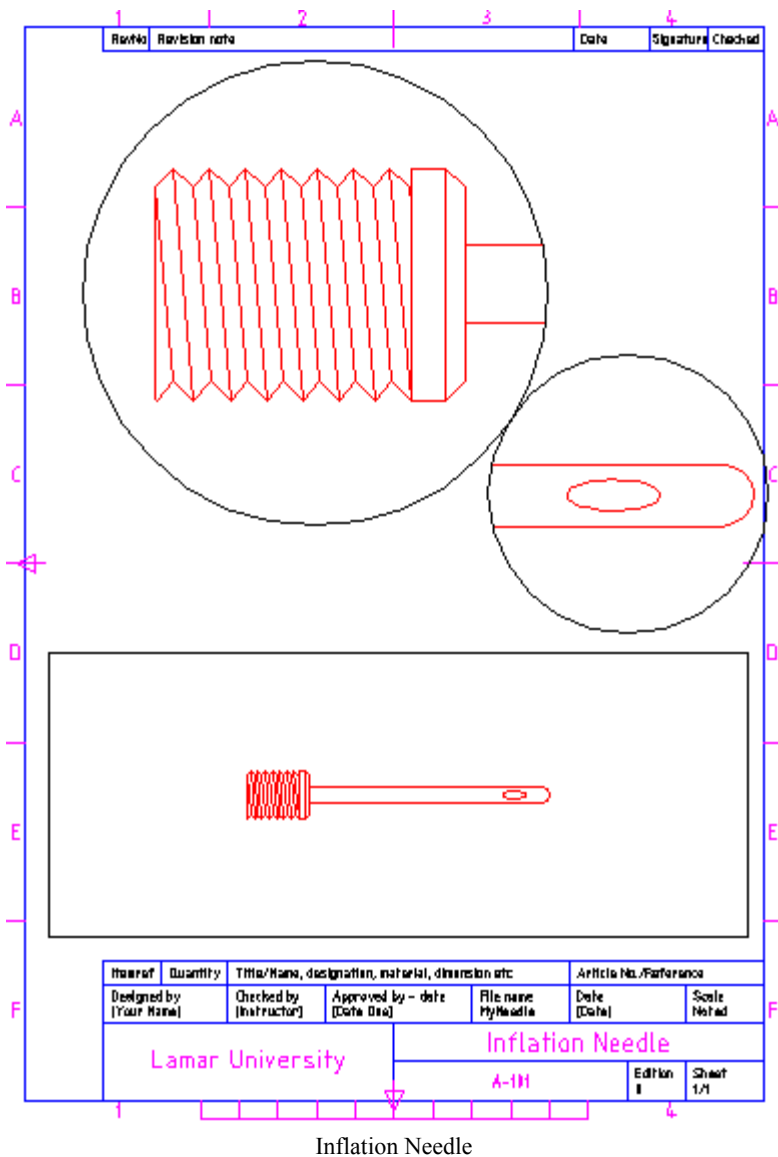

2. Open the *cable splitter* file in the C:\Steps\Lesson24 folder. Create the drawing configuration for plotting found below. Some helpful information includes:
  - 2.1. The page size is 11 x 8½”.
  - 2.2. Watch your layers (place viewports on the **VPorts** layer).
  - 2.3. The radius of the circle is 1.75”.
  - 2.4. The title block is the *ANSI A title block* file found in AutoCAD’s Template folder.
  - 2.5. The scale of each viewport is 4:1 (upper left), 4:1 (lower left), and 1:1 (right).
  - 2.6. Fill in the title block as desired.
  - 2.7. Save the drawing as *MySplitter* in the C:\Steps\Lesson24 folder.

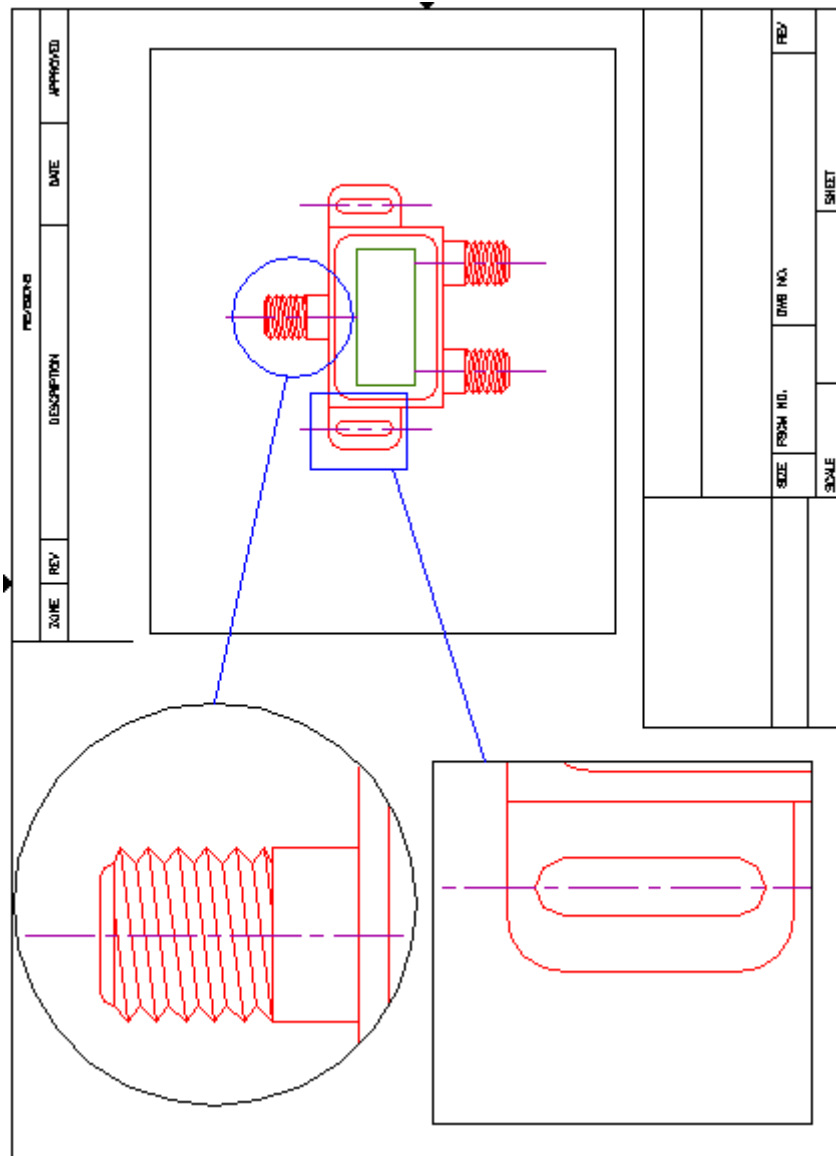

Cable Splitter.dwg

3. Open the *glass cutter* file in the C:\Steps\Lesson24 folder. Create the drawing configuration for plotting shown. Some helpful information includes:
  - 3.1. The page size is 11" x 8½".
  - 3.2. Watch your layers (place viewports on the **VPorts** layer).
  - 3.3. The radius of the circle is 1.25".
  - 3.4. The title block is the *ANSI A title block* file found in AutoCAD's Template folder.
  - 3.5. The scale of each viewport is 4:1 (upper left), 2:1 (upper right), and 1:2 (lower).
  - 3.6. Fill in the title block as desired.
  - 3.7. Save the drawing as *MyCutter* in the C:\Steps\Lesson24 folder.

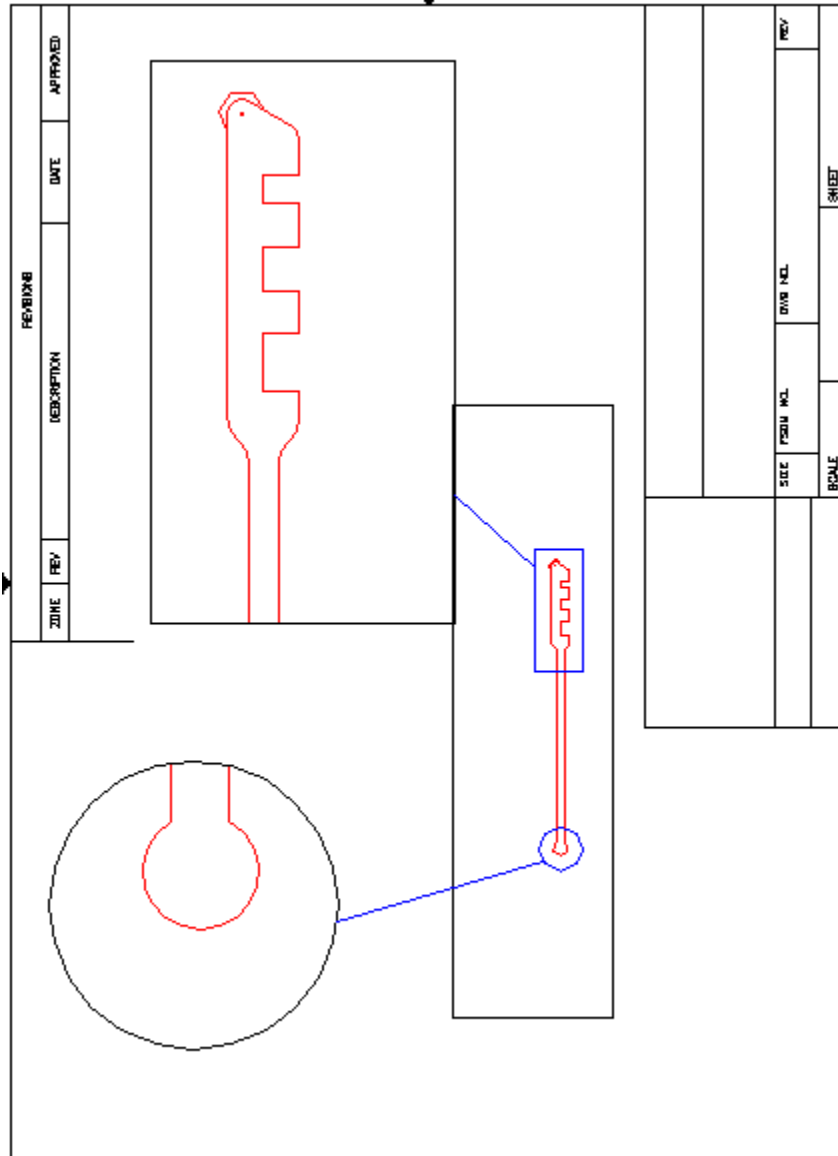

Glass Cutter

4. Open the *Spice Rack* file in the C:\Steps\Lesson24 folder. Create the drawing configuration for plotting shown. Some helpful information includes:
  - 4.1. The page size is 11" x 8½".
  - 4.2. Watch your layers (place viewports on the **VPorts** layer).
  - 4.3. The title block is the *ANSI A title block* file found in AutoCAD's Template folder.
  - 4.4. The scale of each viewport is 1:1 (upper left), 1:1 (lower left), and 6"=1' (right).
  - 4.5. Fill in the title block as desired.
  - 4.6. Save the drawing as *My Spice Rack* in the C:\Steps\Lesson24 folder.

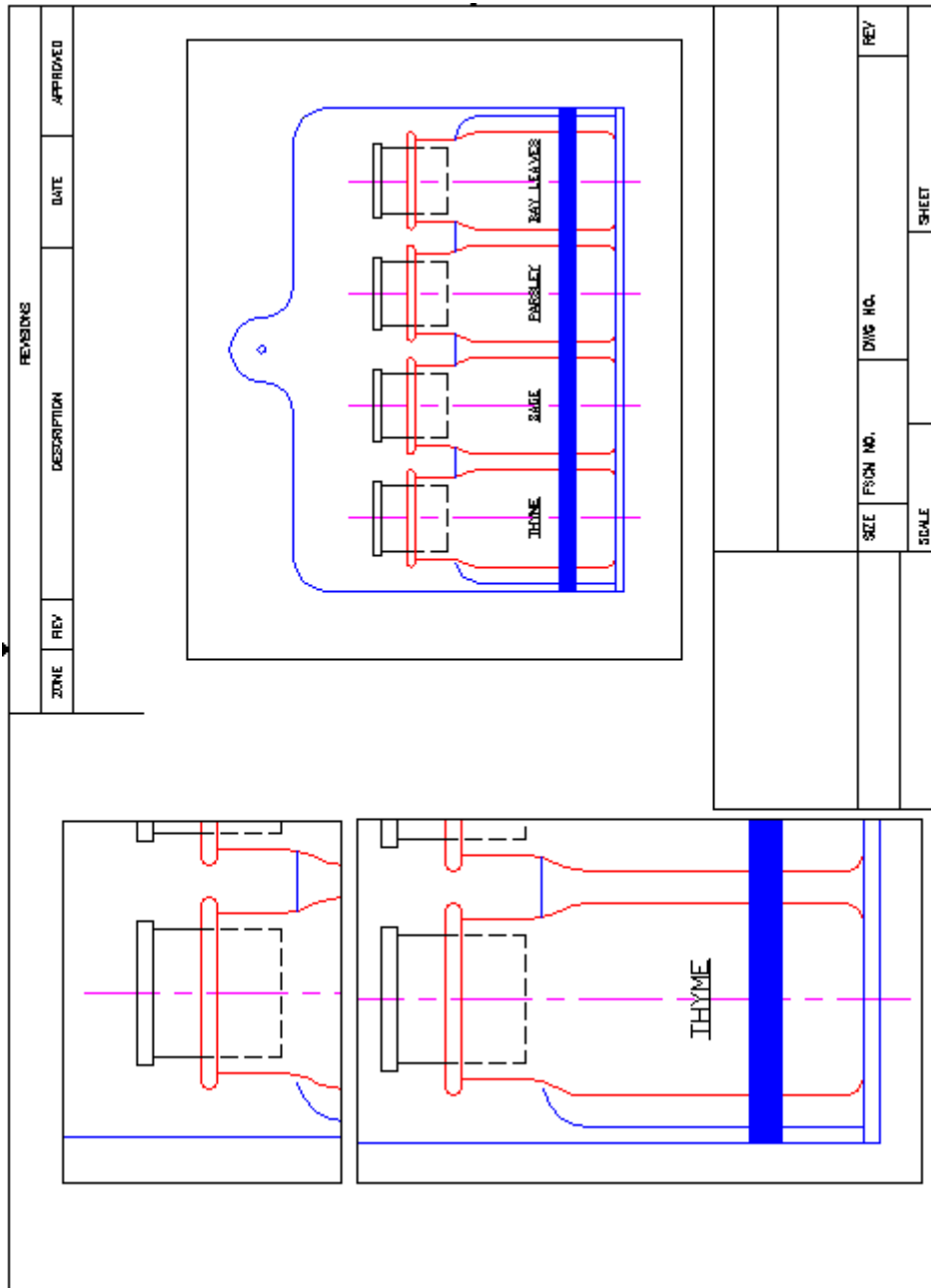

Spice Rack

5. Open the *motor-assbly* file in the C:\Steps\Lesson24 folder. Create the drawing configuration for plotting shown. Some helpful information includes:
  - 5.1. The page size is 17" x 11". (Hint: If your printer won't support this sheet size, set up the page using **NONE** as the printer. AutoCAD will then make all of the sheet sizes available to you.)
  - 5.2. Watch your layers (place viewports on the **VPorts** layer).
  - 5.3. The title block is the *ANSI B title block* file found in AutoCAD's Template folder.
  - 5.4. The scale of each viewport is 1:2 (upper left), 1:2 (lower left), and 1:2 (right).
  - 5.5. Fill in the title block as desired.
  - 5.6. Save the drawing as *MyAssbly* in the C:\Steps\Lesson24 folder.

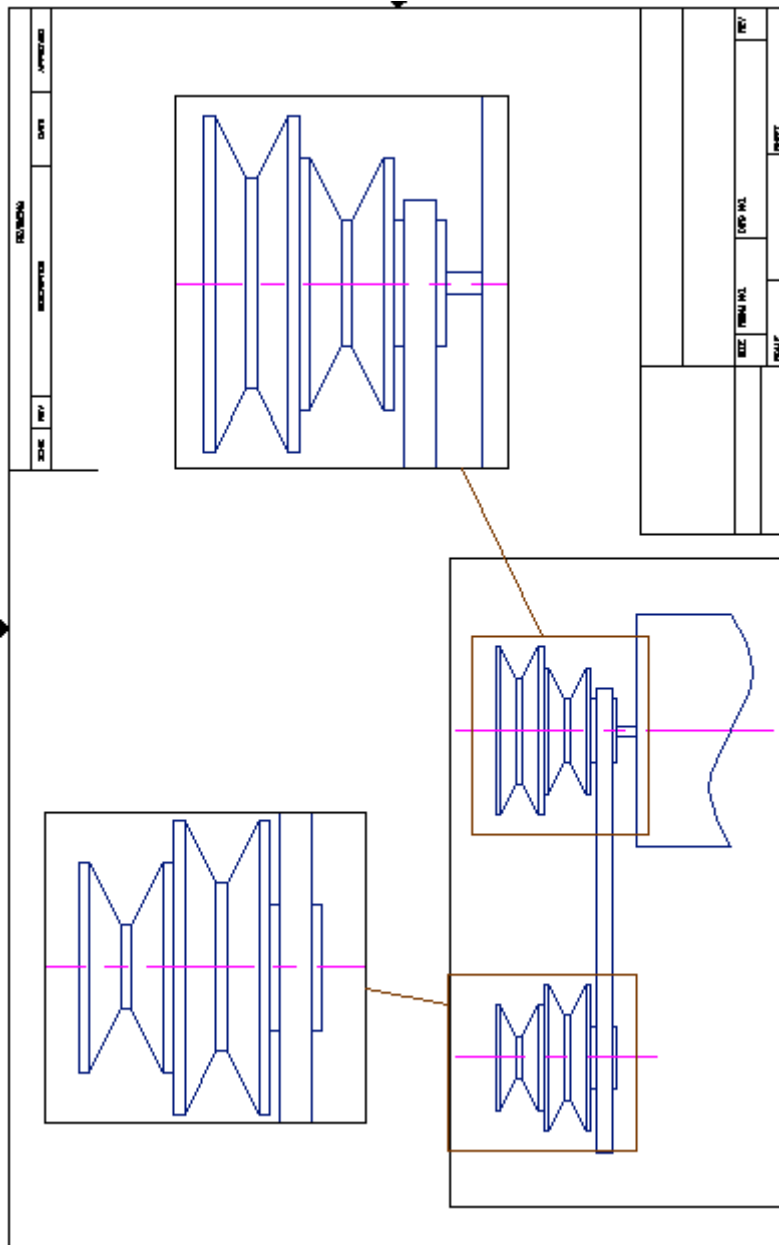

Motor Assembly

6. Open the *remote24* file in the C:\Steps\Lesson24 folder. Create the drawing configuration for plotting shown. Some helpful information includes:
  - 6.1. The page size is 11" x 8½".
  - 6.2. Watch your layers (place viewports on the **VPorts** layer).
  - 6.3. The title block is the *ANSI A title block* file found in AutoCAD's Template folder.
  - 6.4. The scale of each viewport is 1:1 (upper left, center left, lower left), and 1:2 (right).
  - 6.5. Fill in the title block as desired.
  - 6.6. Save the drawing as *MyRemote* in the C:\Steps\Lesson24 folder.

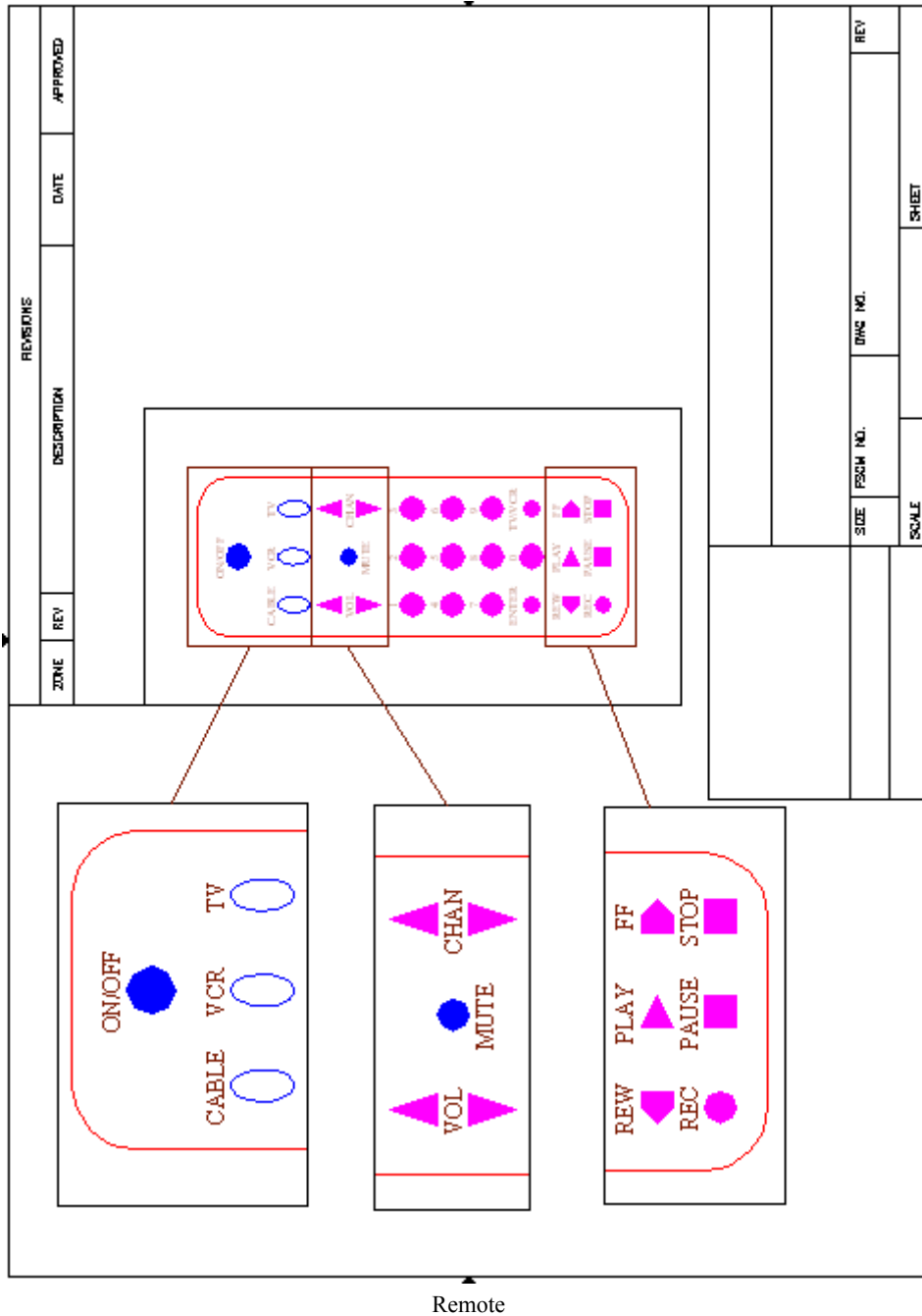

7. Open the *Cabin* file in the C:\Steps\Lesson24 folder. Create the drawing configuration for plotting shown. Some helpful information includes:
  - 7.1. The page size is 34" x 22".
  - 7.2. Watch your layers (place viewports on the **VPorts** layer).
  - 7.3. The title block is the *ANSI D title block* file found in AutoCAD's Template folder.
  - 7.4. The scale of each viewport is 1:1 (upper left and upper right), and 6"=1' (lower left and lower right).
  - 7.5. Fill in the title block as desired.
  - 7.6. Save the drawing as *MyCabin* in the C:\Steps\Lesson24 folder.

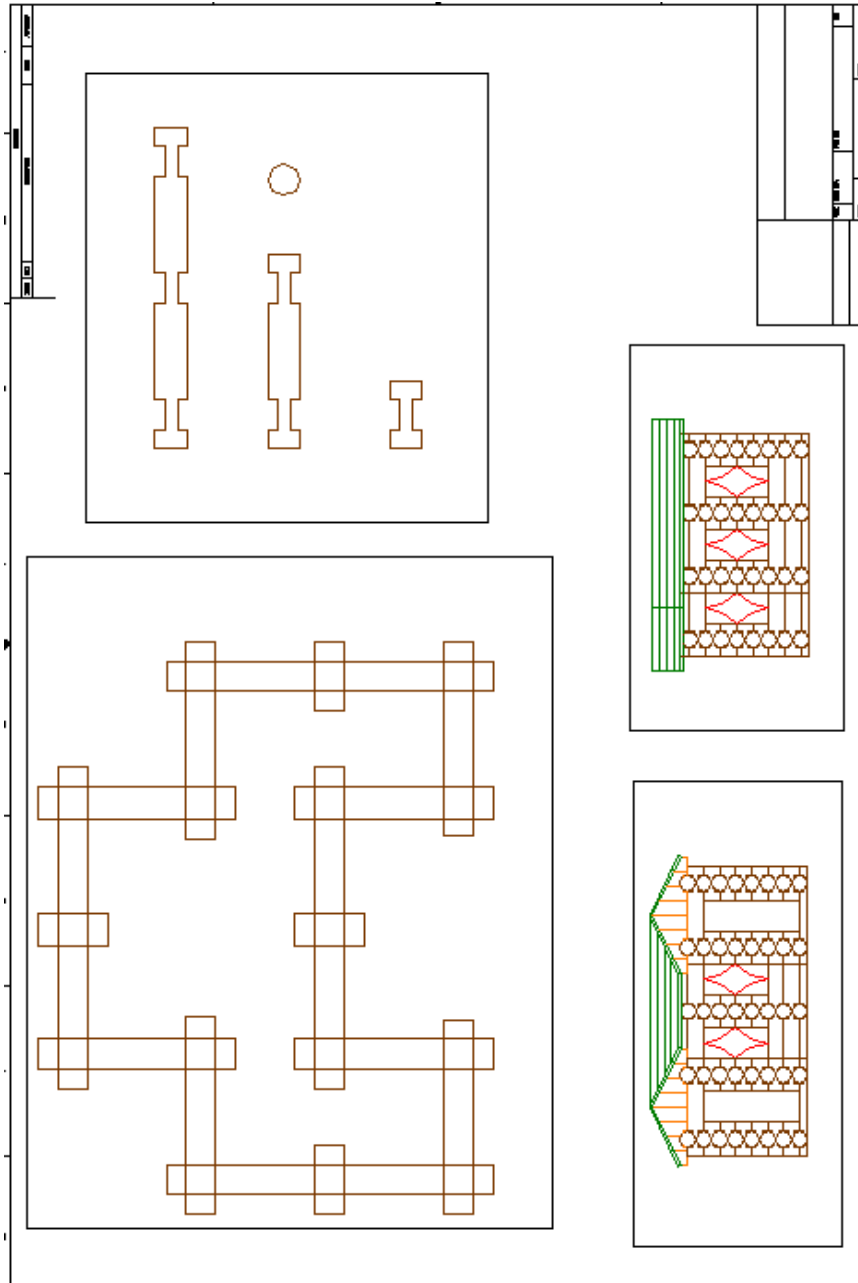

Cabin

8. Open the *Piping plan 24* file in the C:\Steps2\Lesson24 folder. Create the drawing configuration for plotting shown. Some helpful information includes:
  - 8.1. The page size is 34" x 22".
  - 8.2. Watch your layers (place viewports on the **VPorts** layer).
  - 8.3. The title block is the *ANSI D title block* file found in AutoCAD's Template folder.
  - 8.4. The scale of each viewport is 3/8"=1' (main), and 3/4"=1' (detail).
  - 8.5. Fill in the title block as desired.
  - 8.6. Save the drawing as *My Piping Plan* in the C:\Steps\Lesson24 folder.

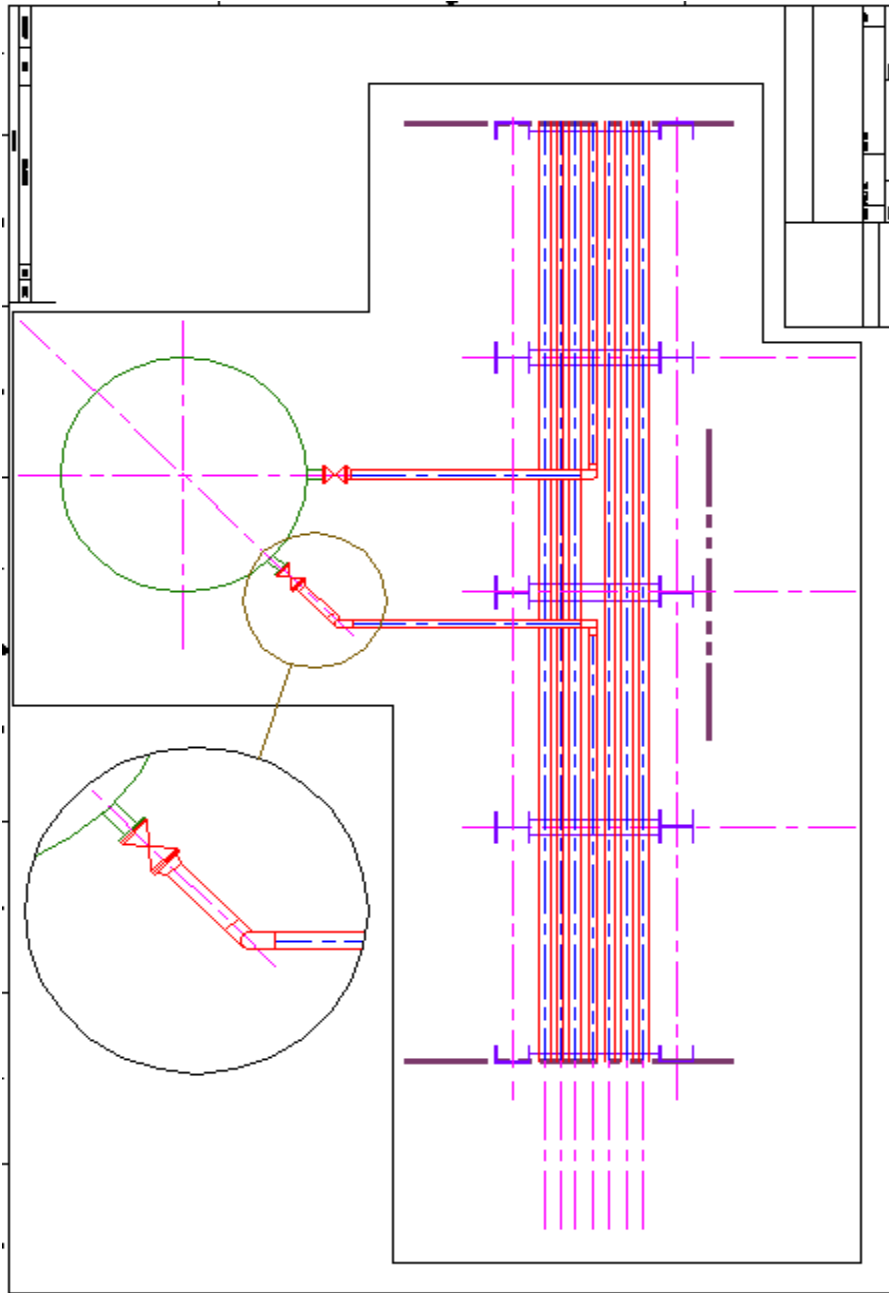

Piping Plan 1

Please write your answers on a separate sheet of paper.

1. A \_\_\_\_\_ can be considered a window into your drawing.

The two types of viewports are (2) and (3)

2.

3.

The two ways to tell which Space you are using are (4) and (5).

4.

5.

The keyboard approach to switching between Model Space and Paper Space is the command (6) (or its hotkey “ms”) or (7) (or its hotkey “ps”).

6.

7.

8. Use \_\_\_\_\_ viewports in Model Space.

9. Access the Viewports dialog box using the \_\_\_\_\_ command.

10. (T or F) It’s possible to place a viewport configuration into a single active viewport.

It’s easy to tell the difference between active and inactive viewports. Active viewports present (11) [crosshairs or cursor arrow] while inactive viewports present a (12) [crosshairs or cursor arrow].

11.

12.

13. To activate a viewport, place the cursor in it and pick once with the \_\_\_\_\_ mouse button.

14. (T or F) Tiled viewports will plot, so it’s important to have them set up properly.

15. Layers behave \_\_\_\_\_ in tiled viewports.

16. (T or F) You can rename a layout tab to help keep track of what’s on it.

17. Paper Space drawings should be plotted at a scale of \_\_\_\_\_.

18. The UCS icon becomes a \_\_\_\_\_ when in Paper Space.

19. (Floating, Tiled) viewports are objects that can be moved.

20. (T or F) Floating viewports must be rectangular.

21. (T or F) Unlike tiled viewports, more than one floating viewport can be active at a time.

22. (T or F) You can work in Model Space from a Layout tab.

23. Use the \_\_\_\_\_ command to create floating viewports.

24. Use the \_\_\_\_\_ command to convert tiled viewports to floating viewports.

25. (T or F) Once a floating viewport has been created, it can’t be modified.

26. Set a 1/4"=1'-0" scale in a floating viewport by using the \_\_\_\_\_ command.
27. If you don't want to use the command in #26, you can use the \_\_\_\_\_ on the status bar.
28. (T or F) Titled viewports are the same as floating viewports.
29. (T or F) All viewports in a titled viewport are active.
30. (T or F) The Setup control box in titled viewports will have only the 2-D option.
31. (T or F) The active viewport only will have crosshairs while inactive viewports will have a cursor arrow.
32. When the user opens flr-plna file and types VPorts at the command prompt
  - a) a dialog box showing standard viewport configurations will appear
  - b) a dialog box with a preview frame will appear
  - c) a suggested viewport arrangement will appear
33. (T or F) You can change the name on a Layout tab by selecting New layout on the right click cursor menu.
34. (T or F) While in Paper Space, the user may erase any part of the drawing.
35. (T or F) When Save is selected on the layout tab's cursor menu, AutoCAD replaces the default layout setup with the current setup.
36. The dashed outline shows the limits of the working area on a page and
  - a) is the only area in which you should work
  - b) can be hidden with the Hide command
37. Use the MView command to
  - a) convert existing closed objects to floating viewports
  - b) insert a title block
  - c) create new floating viewports
38. The option of the MView command used to create floating viewports of any size or shape is
  - a) Restore
  - b) Fit
  - c) Polygonal.
39. (T or F) The Fit option – where the user may pick two diagonal points any distance from one another to make a viewport of any size – is the default for the MView command.
40. (T or F) To use the wizard you can type layoutwizard, or go to the tools pull-down menu.
41. (T or F) At the LayoutWizard command, the Create Layout - Begin dialog box will appear where the name of the layout may be entered.
42. (T or F) The default layout is Portrait.
43. In the Layout - Pick Location box, Select Location refers to: 1) an array of viewports, 2) a single viewport location.
44. (T or F) With the Layout Wizard, the user must tell AutoCAD to use Inches or Millimeters in the Paper Size dialog box.

## Answers

1. Viewport
2. Tiled
3. Floating
4. UCSIcon
5. Status bar
6. MSpace
7. PSpace
8. Tiled
9. Viewports (or vports)
10. T
11. Crosshairs
12. Cursor arrow
13. Left
14. F
15. Universally
16. T
17. 1:1
18. Triangle
19. Floating
20. F
21. F
22. T
23. MView
24. MView
25. F
26. Zoom
27. Viewport Scale control
28. F
29. F
30. F
31. T
32. a & b
33. F
34. F
35. T
36. a
37. all are correct
38. c
39. T
40. T
41. T
42. F
43. 2
44. T