

**AutoCAD 2008: One Step at a Time**  
**Lesson 5: Geometric Shapes (Other than Lines, Circles, and Rectangles)**

08R5

Exercises

1. Use the *MyIsoGrid2* template you created in Lesson 3 (or the *IsoGrid2* template in the Lesson03 folder) to create this drawing. Save the drawing as *MyIsoBlockwithEllipses* in the C:\Steps\Lesson05 folder.

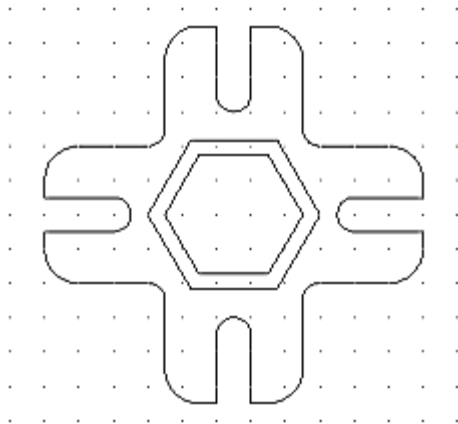
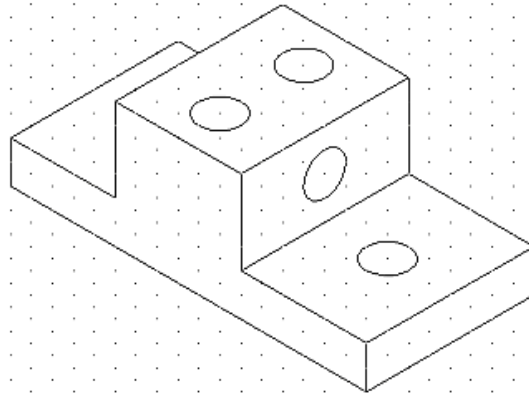

2. Using the *MyBase3* template you created in Lesson 1 (or the *Base3* template in the Lesson01 folder), create this drawing. Save the drawing as *MyHolder* in the C:\Steps\Lesson05 folder.

3. Using the *MyGrid* template you created in Lesson 3 (or the *Grid1* template in the Lesson03 folder), create this drawing. Save it as *MySlideGuide* in the C:\Steps\Lesson05 folder. (Note: Change the grid spacing to 1/2".)

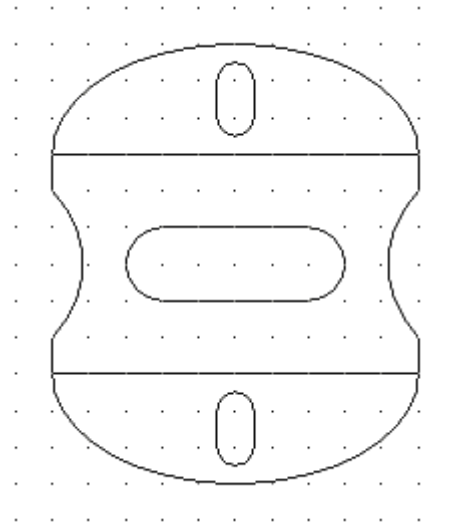

4. Using what you have learned, create the drawing below. The grid is 1/8".

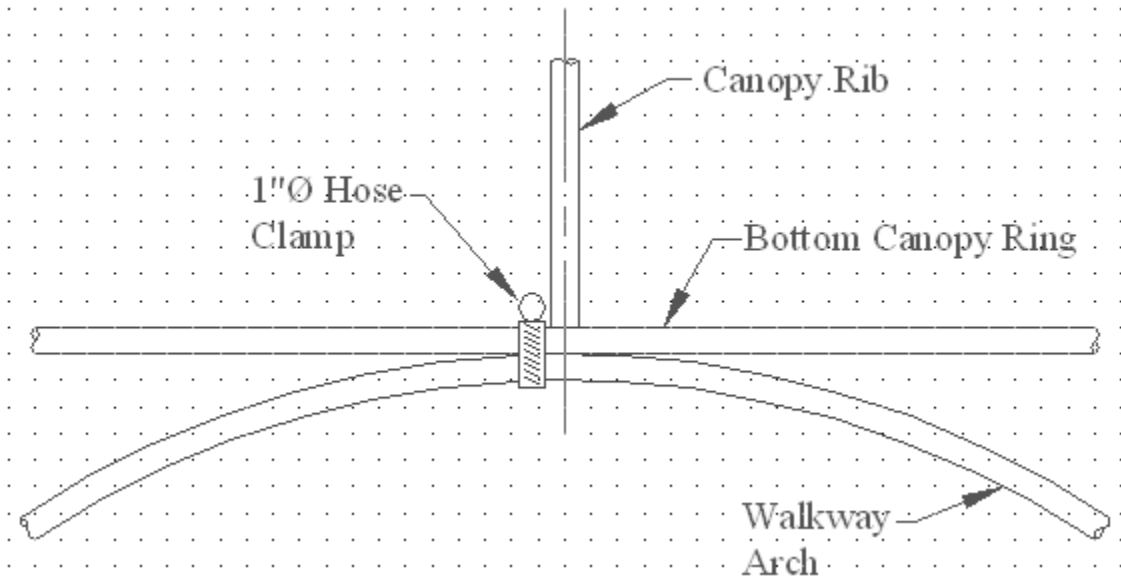



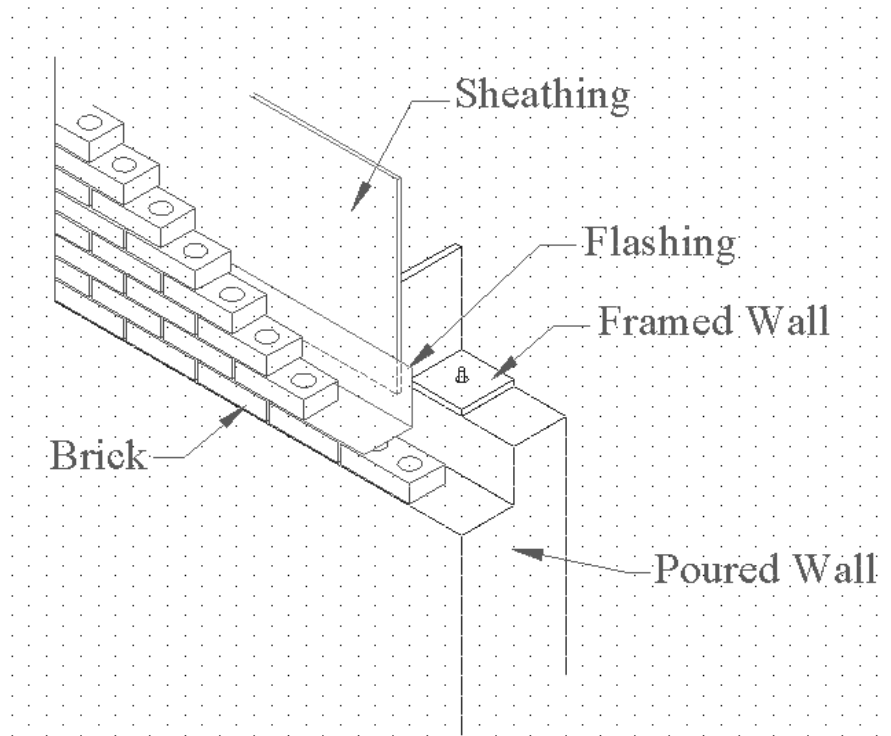







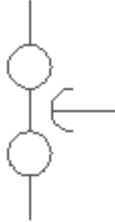

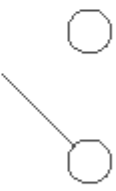
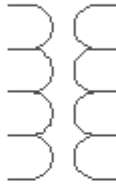





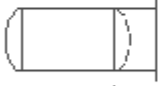

5. Create the isometric drawing shown below. The grid is 2". See if you can create the hidden lines on your own. (Don't worry if you can't, I'll show you how in Chapter 6.)

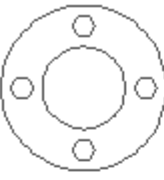







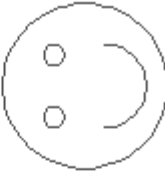



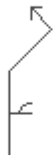

Wall Isometric

6. Now create the following detail sheets. Use the title block you used in Lesson04, Exercise 5. (I used a 1/4" grid to create the detail sheets.)

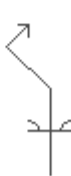
 <p><u>Electrolytic Capacitor</u></p>	 <p><u>Air-Core Inductor</u></p>	 <p><u>Terminal</u></p>	 <p><u>Feed-Thru Capacitor</u></p>								
 <p><u>Coaxial Cable</u></p>	 <p><u>Switch</u></p>	 <p><u>Air-Core Transformer</u></p>	 <p><u>Transistor</u></p>								
 <p><u>Logic Circuit</u></p>	 <p><u>Incandescent Lamp</u></p>	 <p><u>Coaxial Connector</u></p>	 <p><u>Multi-Movable Connector</u></p>								
<p><b>North Harris College</b></p> <p>Sample Electrical Symbols</p> <table border="1" style="width: 100%; border-collapse: collapse;"> <tr> <td style="width: 25%;">Drawn By: [your name]</td> <td style="width: 25%;">Checked By: B. Franklin</td> <td style="width: 25%;">Project No.: [your name]</td> <td style="width: 25%;"></td> </tr> <tr> <td>Date: [date]</td> <td>Scale: NTS</td> <td>Approval: FDR</td> <td>Str. 2 of 2</td> </tr> </table>				Drawn By: [your name]	Checked By: B. Franklin	Project No.: [your name]		Date: [date]	Scale: NTS	Approval: FDR	Str. 2 of 2
Drawn By: [your name]	Checked By: B. Franklin	Project No.: [your name]									
Date: [date]	Scale: NTS	Approval: FDR	Str. 2 of 2								

 <p><u>Socket Weld Tee (Top View)</u></p>	 <p><u>Vertical Vessel w/ 30° Elliptical Heads</u></p>	 <p><u>Pipe Break</u></p>	 <p><u>Flange (End View)</u></p>								
 <p><u>90° Ell</u></p>	 <p><u>90° Ell (Top View)</u></p>	 <p><u>90° Socket Weld Ell</u></p>	 <p><u>Blind Flange</u></p>								
 <p><u>90° Threaded Ell</u></p>	 <p><u>Horizontal Vessel w/ 30° Elliptical Heads</u></p>	 <p><u>Ball Valve</u></p>	 <p><u>Happy Piper</u></p>								
<p><b>North Harris College</b></p>											
<p>Sample Piping Symbols</p> <table border="1" style="width: 100%; border-collapse: collapse;"> <tr> <td style="width: 25%;">Drawn By: [name]</td> <td style="width: 25%;">Checked By: B. Franklin</td> <td style="width: 25%;">Project No.: [course number]</td> <td style="width: 25%;"></td> </tr> <tr> <td>Date: [date]</td> <td>Scale: NTS</td> <td>Approval: FER</td> <td>Sheet 2 of 2</td> </tr> </table>				Drawn By: [name]	Checked By: B. Franklin	Project No.: [course number]		Date: [date]	Scale: NTS	Approval: FER	Sheet 2 of 2
Drawn By: [name]	Checked By: B. Franklin	Project No.: [course number]									
Date: [date]	Scale: NTS	Approval: FER	Sheet 2 of 2								

 <u>Projection</u>	 <u>Seam</u>	 <u>Surfacing</u>	 <u>Full Around</u>
 <u>U Both Sides</u>	 <u>U Both Sides</u>	 <u>J</u>	 <u>Flare Bevel Both Sides</u>
 <u>J Both Sides</u>	 <u>Flare V</u>	 <u>Flare V Both Sides</u>	 <u>Flare Bevel</u>
<b>North Harris College</b>			
Sample Welding Symbols			
Drawn By: [your name]		Checked By: B. Foulon	
Date: [date]		Approval: FDR	
		Project No.: [course num]	
		Page: 2 of 2	

7. Now see what you can do with the following drawings.

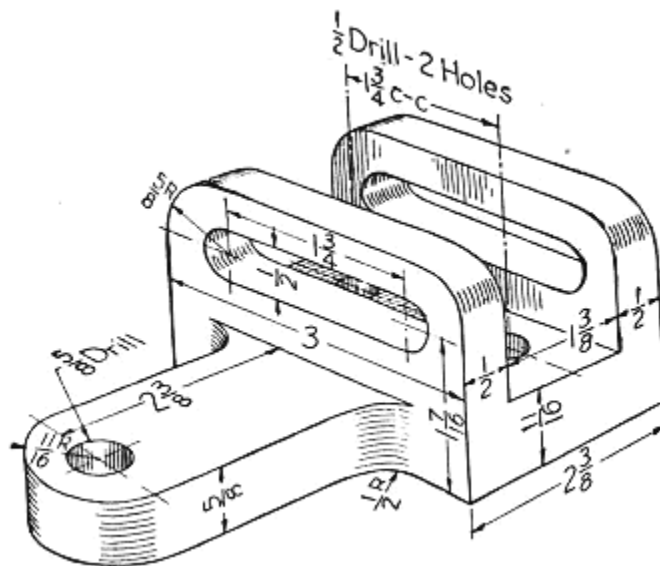
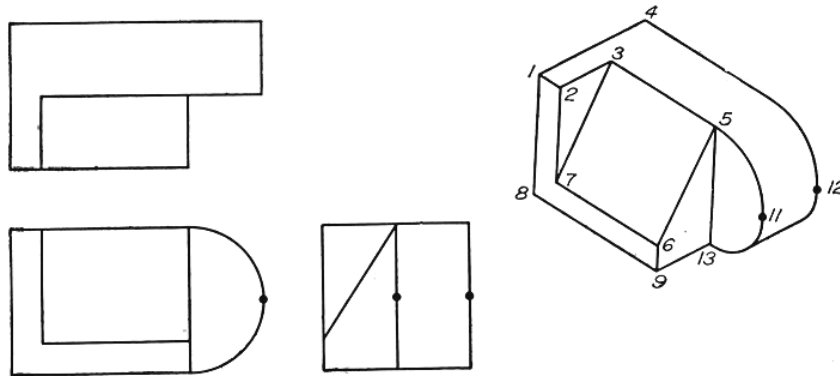
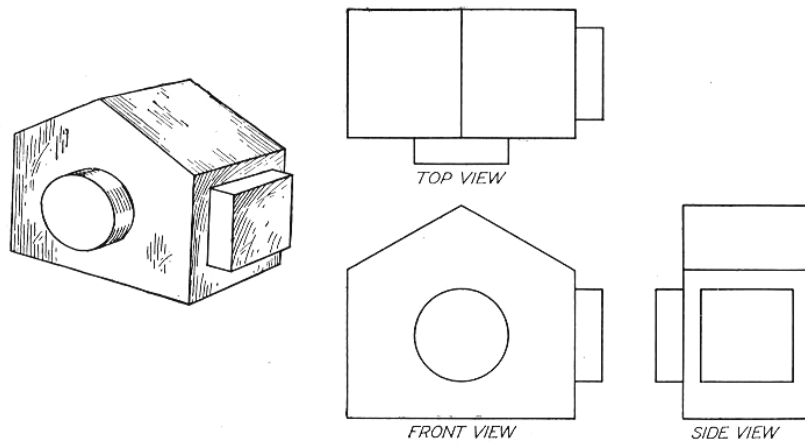



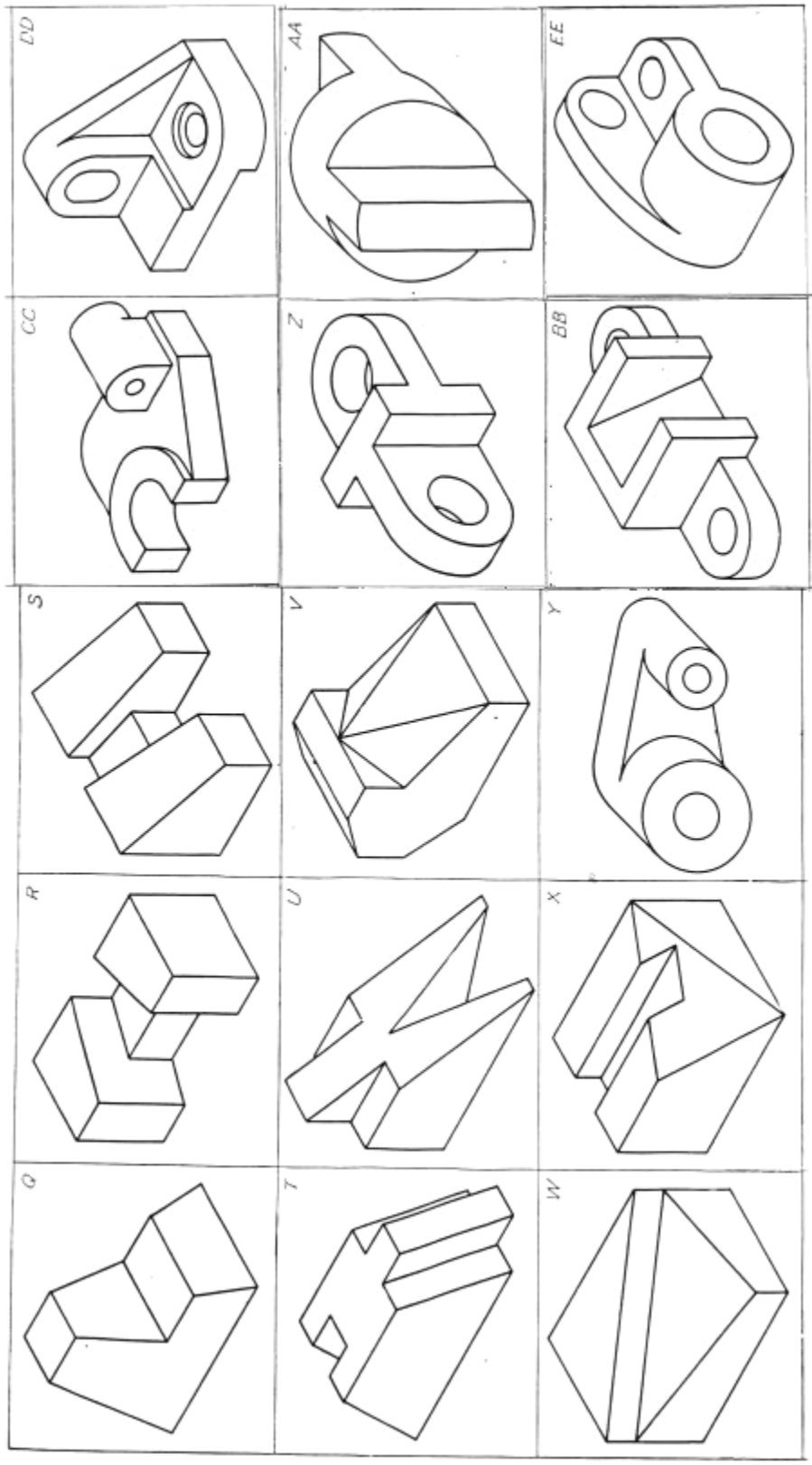



Please write your answers on a separate sheet of paper.

Using the Ellipse command defaults, what three points must the user identify to draw the ellipse?

- 1.
- 2.
- 3.
8. The \_\_\_\_\_ option of the Ellipse command allows the user to draw partial ellipses.
9. The drawing must be in \_\_\_\_\_ mode to draw isocircles.
10. By default, AutoCAD draws true ellipses. However, the user may draw polyline ellipses by changing the \_\_\_\_\_ sysvar to 1.
11. (T or F) It's easy to find the center of a polyline ellipse.

Identify these buttons:



8.    9.    10.    11.    12.

What are the three ways the user can end a Start - Center arc?

- 13.
- 14.
- 15.
16. By default, AutoCAD draws arcs in the \_\_\_\_\_ direction.
17. To draw an arc in a different direction, use the \_\_\_\_\_ option.
18. What must the user do at the first arc prompt to continue the last arc drawn?

What are the two approaches to drawing a polygon?

- 19.
- 20.
21. How many sides can an AutoCAD polygon have?

Using the circle approach, the user can place the polygon either (22) in or (23) around an imaginary circle.

- 22.
- 23.
24. \_\_\_\_\_ is the hotkey entry for the Polygon command.

25. The command used to reset the interval between automatic saves in AutoCAD is \_\_\_\_\_.
26. By default, AutoCAD automatically saves a backup drawings every \_\_\_\_\_ minutes.
27. \_\_\_\_\_ are AutoCAD's way of allowing the user to manually configure the software for optimal performance.
28. A running OSNAP is
- a. a marathon runner
  - b. an OSNAP setting which activates automatically
  - c. first word in a line of music
29. The "El" hotkey will prompt the user
- a. for a name to go with it (El Circle)
  - b. specify axis endpoints
  - c. specify the distance to another axis endpoint
30. (T or F) The Center option of the Ellipse command requires a diameter value to complete the shape.
31. (T or F) The drafter may construct an elliptical arc by using the Ellipse command.
32. (T or F) To obtain the Isocircle option in the Ellipse command, your drawing needs to be in the isometric mode.
33. The hotkeys SN can be used to set
- a. the isometric mode
  - b. straight number lock
  - c. snap settings
34. (T or F) When you pick Node from the OSNAP flyout toolbar, AutoCAD will snap your crosshairs to a point or node.
35. (T or F) Ellipses are always polylines.
36. (T or F) The Ellipse command will normally offer an Isocircle option.
37. To activate the Arc command the user can
- a. type Arc, or the A hotkey
  - b. select the Arc button on the 2D Draw control panel
  - c. hold down the shift key and press "RC"

38. The Length of Chord option within one of the Arc command's options refers to
- the circumference of the circle from which the arc originates
  - the true length of an arc
  - the length of the radius
39. Angle – in the Start, End, Angle procedure of drawing an arc – refers to
- the angle of incidence + the radius squared
  - the angle of incidence + the diameter
  - the angle at which your arc will be drawn
40. (T or F) Arcs can be drawn counterclockwise only.
41. (T or F) Hitting enter twice after completing the Arc command will restart the command and use the end of the last arc as the start point of the new one.

## Answers

- |                      |                                   |
|----------------------|-----------------------------------|
| 1. Axis Endpoint 1   | 22. Inscribed                     |
| 2. Axis Endpoint 2   | 23. Circumscribed                 |
| 3. Other Axis        | 24. Pol                           |
| 4. Arc               | 25. Savetime                      |
| 5. Isometric         | 26. 10                            |
| 6. Pellipse          | 27. Sysvars (or system variables) |
| 7. F                 | 28. b                             |
| 8. Arc               | 29. b & c                         |
| 9. Circle            | 30. F                             |
| 10. Ellipse          | 31. T                             |
| 11. Save             | 32. T                             |
| 12. Polygon          | 33. a & c                         |
| 13. End              | 34. T                             |
| 14. Angle            | 35. F                             |
| 15. cordLength       | 36. F                             |
| 16. Counterclockwise | 37. a & b                         |
| 17. D Or Direction   | 38. b                             |
| 18. Hit Enter        | 39. c                             |
| 19. Circle           | 40. F                             |
| 20. Edge             | 41. T                             |
| 21. 1024             |                                   |